

---

# Table of Contents

## WIDE SCREEN ON-BOARD MONITOR

Subject	Page
Introduction. . . . .	3
Component overview. . . . .	4
Principle of operation. . . . .	7
Workshop Hints. . . . .	7
Review Questions. . . . .	9

---

## WIDE SCREEN ON-BOARD MONITOR

Model: E39,E38,E46,E53

Production Date: E38,E39 from 9/00  
E53 from 1/01  
E46 Cabrio from 3/01  
all other E46 models from 9/01

### Objectives

After completing this module you should be able to:

- Describe the benefits of the wide screen monitor over the previous versions.
- Understand how to operate the wide screen monitor.
- Review the procedures to access the Service Modes.

## Introduction

While the instrument cluster provides all of the important vehicle status information to the driver, the on-board monitor is designed as an additional display that can be viewed by both the driver and vehicle passengers. Information relating to the vehicle, navigation, audio system and telephone can be displayed and controlled from a central location.

The wide screen on-board monitor replaces both the 5.5" versions in the E38 and E39, and the 5" board monitor from the E53 and E46. The wide screen display has a screen size of 6.5" and an aspect ratio (length:height) of 16:9.

### The benefits of the wide screen design are:

- Larger display area and higher resolution (400X234 pixels).
- Improved display screen technology (Ad-TFT LC).
- Bigger text size.
- Soft keys replace country specific audio function keys.
- Used for all board monitor applications in all markets reducing variants.
- Larger display area makes split screen and magnification features possible (future software enhancements).



---

## Component Overview

The wide screen on-board monitor consists of:

1. Monitor housing with cassette drive
2. Display screen
3. On-board monitor control panel

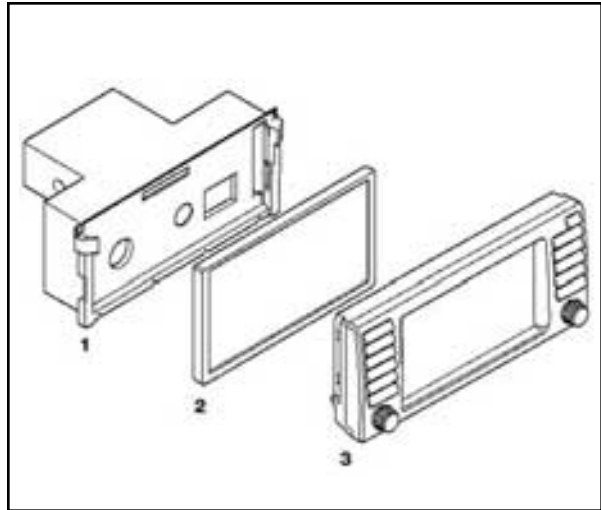

### Cassette Drive

The cassette drive is located behind the on-board monitor screen. In order to access the cassette, press the "eject" button, the display screen tilts forward to uncover the cassette slot. The images will remain displayed on the screen.

After pressing the "eject" button again or automatically after 15 seconds the display returns to its normal position (cassette must be completely inside or removed). The tilt mechanism for the display screen utilizes anti-trap, if the board monitor detects a sudden change in speed, the display will reverse direction.



## Display Screen and Control Panel

The display screen has a diagonal width of 6.5" and an aspect ratio of 16:9 compared to the previous monitors that had a ratio of 4:3. The new screen also uses a Ad-TFT display (Advanced Thin Film Transistor). This type of screen uses ambient light in addition to back-lighting in order to illuminate the display. The advantage is a constant contrast and brightness level at all ambient lighting conditions.

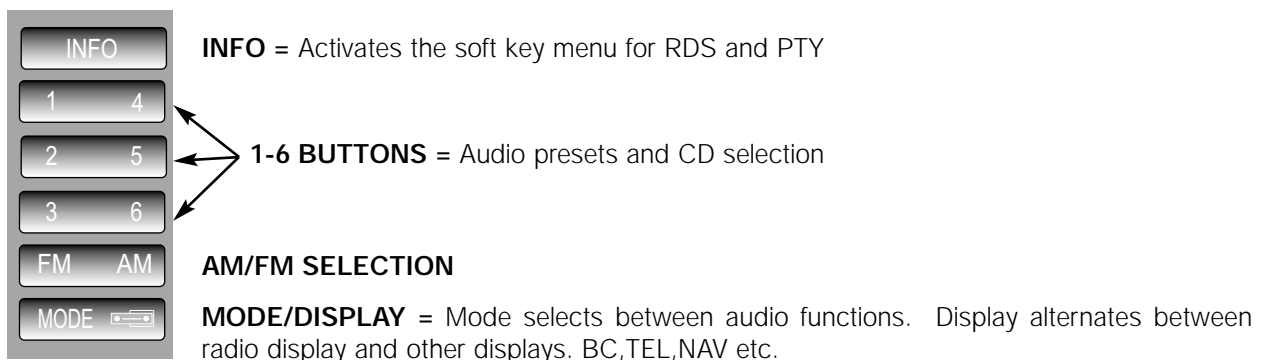
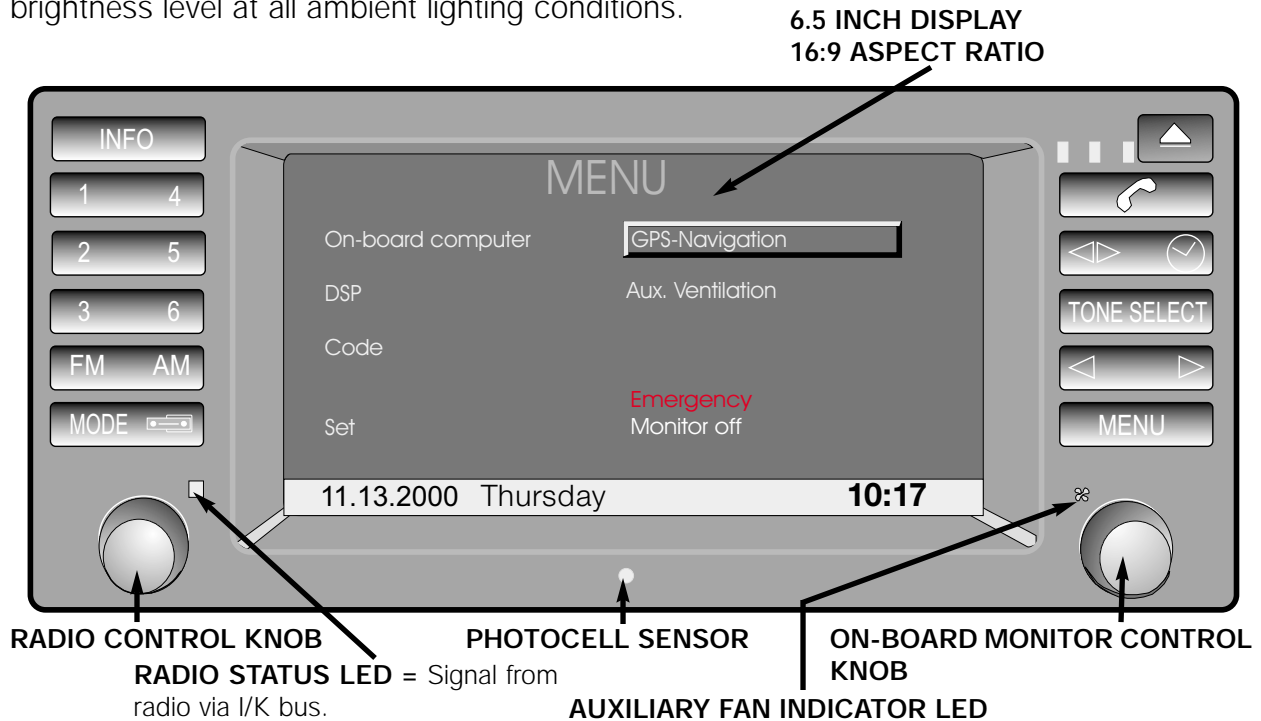

**TELEPHONE STATUS LEDs / EJECT** = Tilts monitor to access cassette drive.

**TELEPHONE** = Send/End button

**TAPE REVERSE/CLOCK** = Clock: Pressing with key off displays time. Aux. ventilation can be switched by holding button longer.

**TONE/SELECT=Tone:** Dolby (cassette only) and audio adjustments.  
**Select:** Choose between station search methods (a,m or scan).

**FAST FORWARD/REVERSE / STATION SEARCH**

**MENU** = Returns display to main menu



# Wide Screen Board Monitor Interface

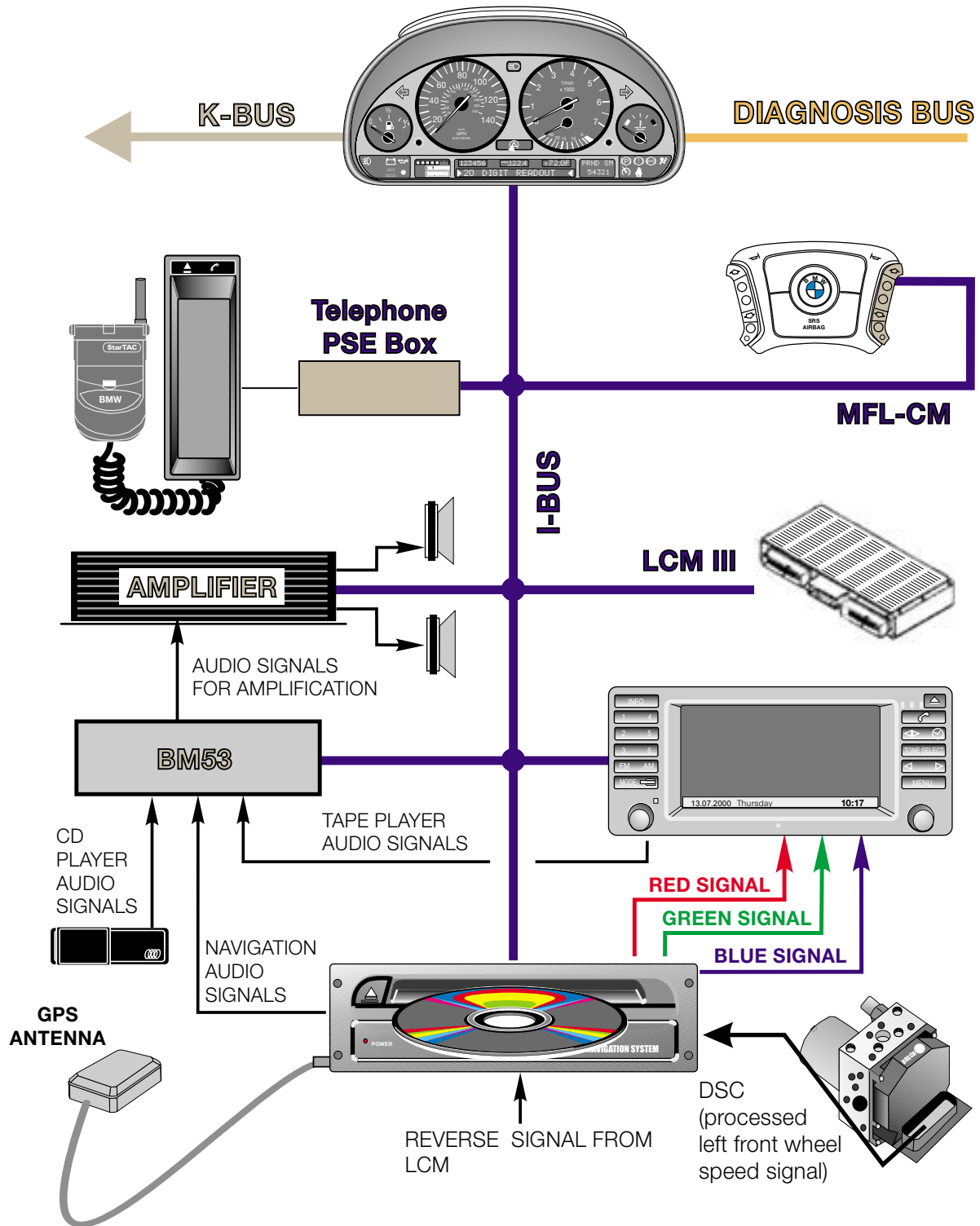

Example of E38/E39 with Wide Screen Board Monitor

## Principle of operation

The on-board monitor is an input and display device that performs no internal calculations.

Inputs from the control panel buttons and knobs are converted into I-bus (K-bus E46) signals by the BM control panel. All of the devices controlled by the BM are connected to the I/K bus interface.

The navigation computer contains the graphics stage integrated into the navigation computer housing. Request for on-board monitor displays are made to the navigation computer via the I/K bus. The navigation computer generates the RGB video signals and transmits them via 3 shielded wires.

Audio signals generated by the cassette drive are sent via traditional audio wires (4) to the radio (located in the trunk or cargo area) for output to the audio system amplifier.

## Workshop Hints

### Service mode

Access for the radio, on-board monitor and navigation service modes is available through the on-board monitor screen.

#### To enter the radio service mode:

- Turn the ignition key to position 1 (KLR).
- Turn the radio on, then off, then on again.
- Press the "INFO" button. From the selection list choose "RDS".
- Press and hold the on-board monitor control knob for at least 8 seconds.
- The audio display window will show the radio serial number as the first display.
- The station search < > buttons are used to scroll through the various settings.
- Turn off the radio to "set" any changes made.

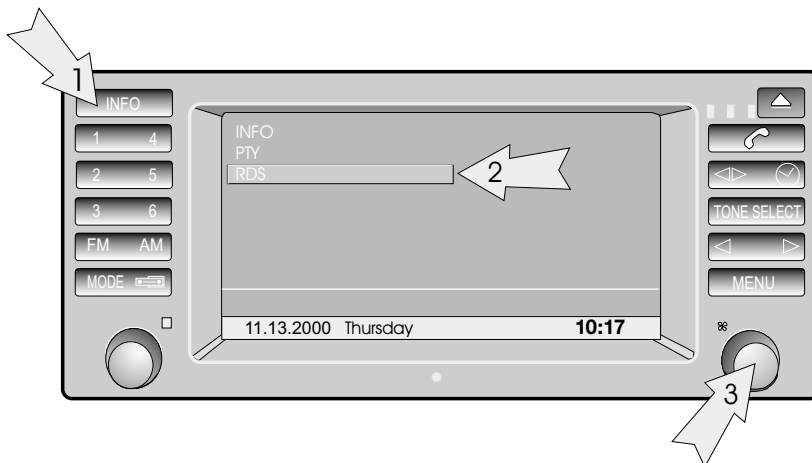

**Note:** See the "NG" Radios module for a list of the tests and settings available in the radio service mode.

### To enter the On-Board Monitor and Navigation Service Mode:

- Turn the ignition key to position 1 (KL R).
- From the Menu screen select "SET".
- Once in the Set screen, press and hold the "MENU" button for 8 seconds.
- The Service Mode menu will appear on the display.
- Select "On-board monitor" for monitor specific tests.

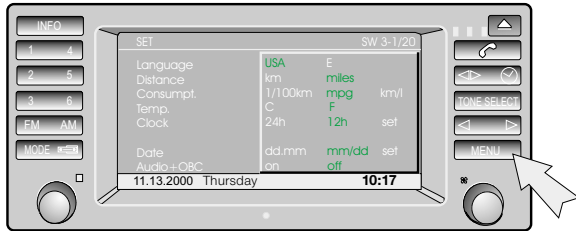

Press and hold for 8 seconds after entering the "SET" screen.

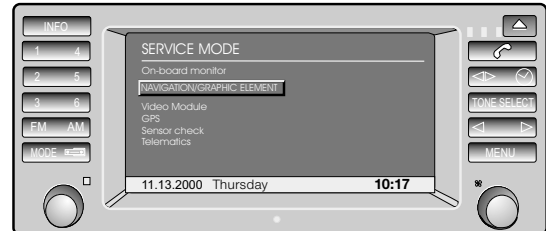

Service Mode main menu display

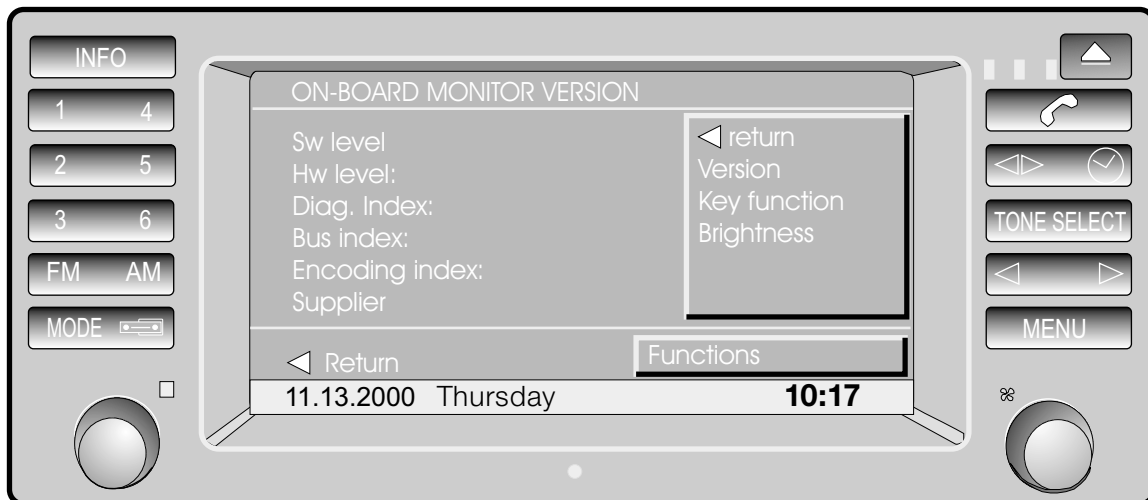

Tests and adjustments available for the on-board monitor are:

- Version Information
- Key Function (button and rotary knob test)
- Brightness (Screen brightness adjustment)



---

## Diagnosis

Fault driven diagnosis is possible using the DIS/MoDiC Diagnosis Program. The Diagnosis Program features:

- Identification
- Read/Clear fault memory
- Diagnosis requests
- Fault driven test modules. (E46 concept)

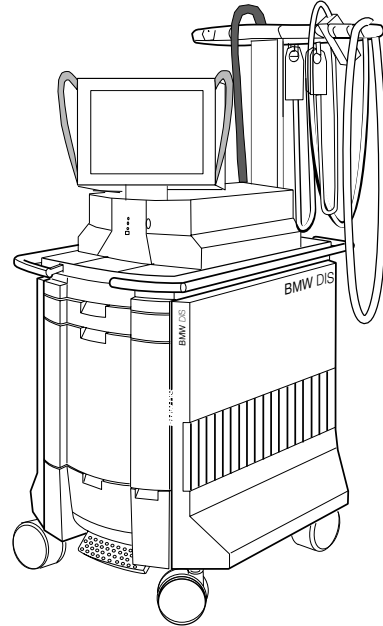

## Review Questions

1. Which component is responsible for providing the display signals to the wide screen on-board monitor? \_\_\_\_\_

\_\_\_\_\_

2. How does the radio receive the control requests from the on-board monitor control panel? \_\_\_\_\_

\_\_\_\_\_

3. What tests and adjustments are available in the service mode that are specific to the on-board monitor? \_\_\_\_\_

\_\_\_\_\_

\_\_\_\_\_